













MIX SZ & MIX SZV SERIEN SPEZIFICATION

MASCHINENTYP [MIX]	300 SZ	500 SZ	1000 SZ	1500 SZ
	300 SZV	500 SZV	1000 SZV	1500 SZV
Gesamtkapazität [L]	300	500	1000	1500
Max füllung [L]	200	320	650	1000
Motorleistung [kW]	2x7,5	2x15	2x22	2x30
Stufenlose Drehzahlregelung der Wellen [rpm]	5/48	4/40	4/30	3/28
Standardsteuerung				
Mischer Nettogewicht [kg]	1300	1780	3400	4600
	1400	1900	3580	4850
Busch vakuumpumpe [m ³ /h]	-	-	-	-
	21	21	40	63
Sicherung [A]	40	100	120	160
Beschickung option	PW 2/250	PW 2/250	PW 2/250	PW 2/250
Entladen Standard-Füllwagen DIN9797	200L 	2x200L 	2x200L 	2x200L 
Deckel öffnen/ Schließen	 H	 H	 H	 H

MODELL DER MASCHINEN [MIX]	300 SZ	500 SZ	1000 SZ	1500 SZ
	300 SZV	500 SZV	1000 SZV	1500 SZV
Mast-Beschickung	<input type="radio"/>	<input type="radio"/>	<input type="radio"/>	<input type="radio"/>
PLC und HMI	S	S	S	S
Glatte variable Geschwindigkeit	S	S	S	S
Temperatursensor	<input type="radio"/>	<input type="radio"/>	<input type="radio"/>	<input type="radio"/>
Wasserdosiersystem	<input type="radio"/>	<input type="radio"/>	<input type="radio"/>	<input type="radio"/>
Wiegeeinrichtung	<input type="radio"/>	<input type="radio"/>	<input type="radio"/>	<input type="radio"/>
“Easy Clean” Wellendichtungen	<input type="radio"/>	<input type="radio"/>	-	-
	-	-		
Zusätzliches Gitter	-	-	-	-
Wellen und Trog poliert	S	S	S	S
Doppeljacke max. Druck 2,0 [bar]	<input type="radio"/>	<input type="radio"/>	<input type="radio"/>	<input type="radio"/>
	<input type="radio"/>	<input type="radio"/>	<input type="radio"/>	<input type="radio"/>
Staubdichter Deckel	S	S	S	S
Flügelwellen	<input type="radio"/>	<input type="radio"/>	<input type="radio"/>	<input type="radio"/>

MIX SZ & MIX SZV SERIEN SPEZIFIKATION

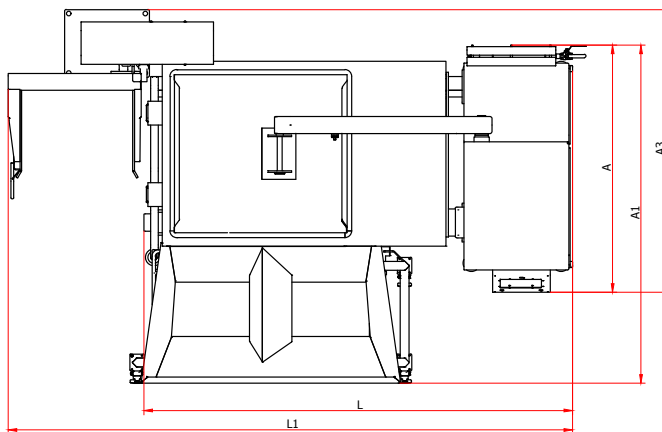
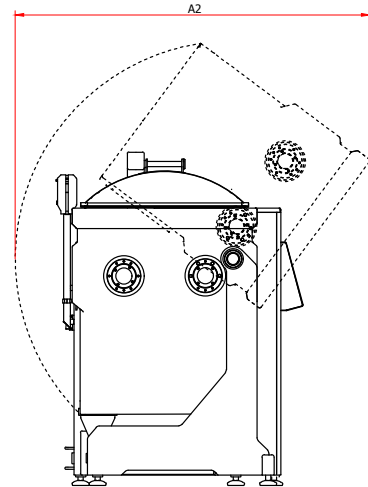
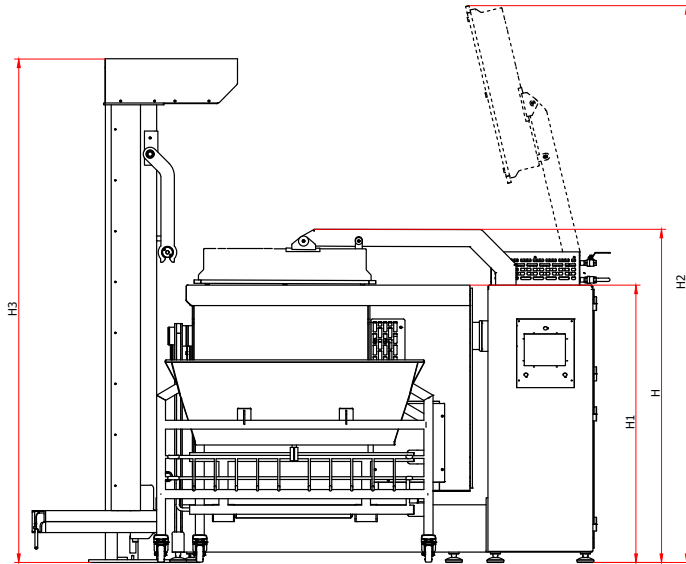

MODELL DER MASCHINEN [MIX]	300SZ	500SZ	1000SZ	1500SZ
	300 SZV	500 SZV	1000 SZV	1500 SZV
H [cm]	163	192	201	228
H1 [cm]	143	164	176	194
H2 [cm]	260	290	328	376
H3 [cm]	250	271	282	300
L [cm]	203	216	278	327
L1 [cm]	283	295	358	407
A [cm]	112	124	162	187
A1 [cm]	172	180	203	234
A2 [cm]	166	181	220	266
A3 [cm]	140	166	186	211